

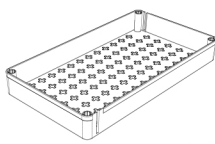





4 Raven skladiščenje voziček

Seznam dodatne opreme

Navedeno je več zapahov. Njihove nastavitvene položaje lahko prilagodite tako, da ustrezajo ašim možnostim uporabe

A mrežasta košara  4PCS	B cev  12PCS	C zapah alfa  6PCS	D zapah beta  4PCS
E kavelj  2PCS	F pokrov  4PCS	G oranžni klobuk  1PC	H kolesček  2PCS 2PCS

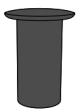
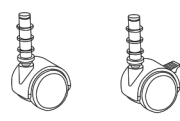
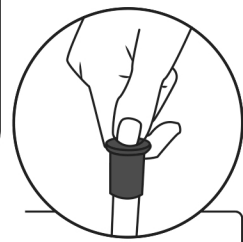

NASVET

Oranžno kapo **G** uporabite za zaščito prsta, ko pritiskate na cevi

*Ne dotikajte se robov jeklenih cevi.

* Med sestavljanjem nosite rokavice

1 Sestavite zapah alfa **C** ali zapah beta **D**

Glede na možnosti uporabe lahko izberete zapah alfa **C** ali zapah beta **D**, da ga namestite v vrzel

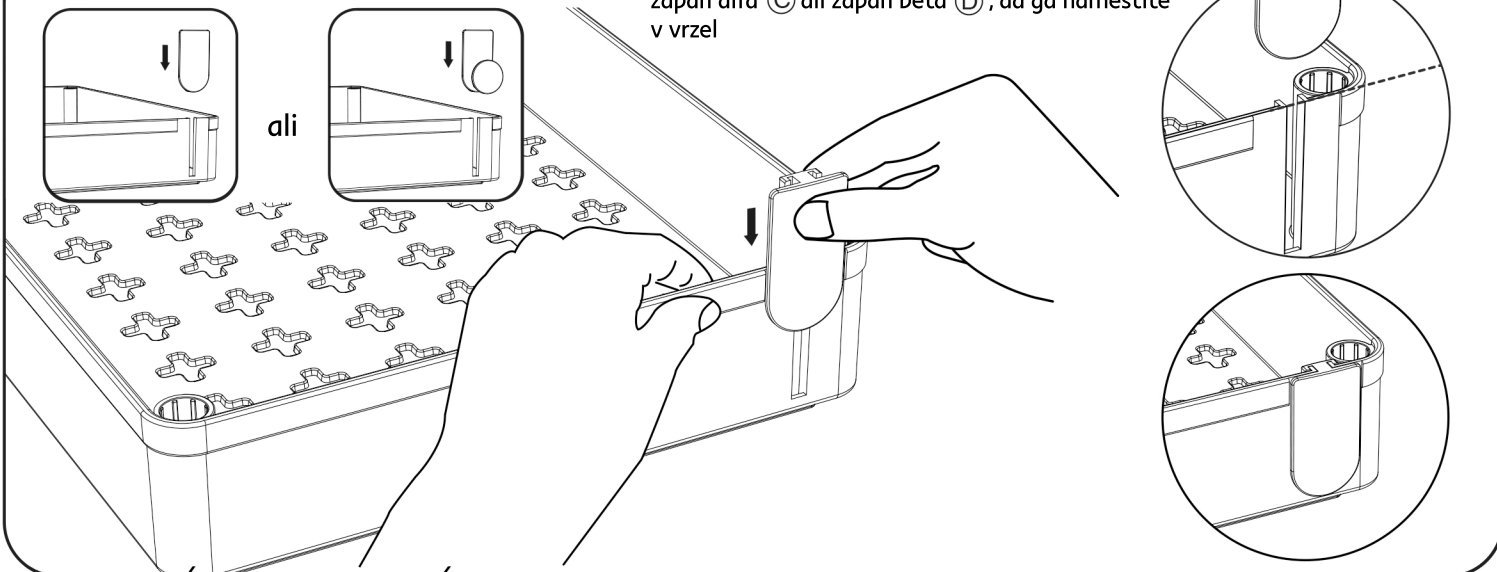

2 Sestavite mrežaste košare **A** in cevi **B**

Da cev iz nerjavnega jekla ne bi bila preveč ostra in ne bi poškodovala vaših rok, je na voljo majhna kapa **G**

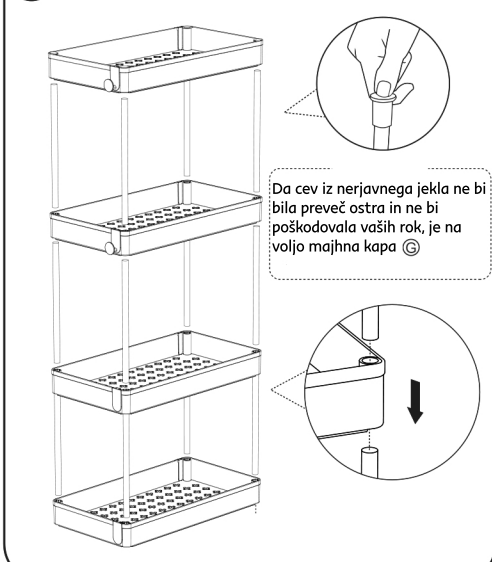

3 Sestavite pokrove **F** in kolesca **H**

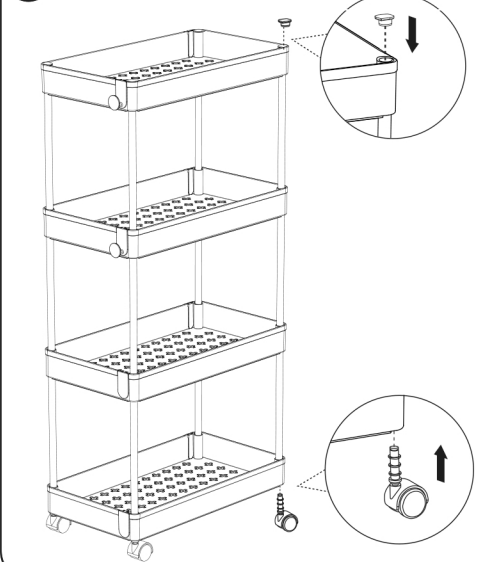

4 Sestavite kavlje **E**

